



**USER  
MANUAL**

**T08 VFD**  
SMART LOCK

---

[www.smartleelen.com](http://www.smartleelen.com)

## Menu

### 1 Important Information

- 1.1 Security
- 1.2 Warning
- 1.3 Disposal Of Old Products And Batteries

### 2 Install The Lock

- 2.1 Product List
- 2.2 Installation Three-dimensional Assembly Drawing
- 2.3 Instructions Before Installation
- 2.4 Bolt Direction Reversing
- 2.5 Installation Video

### 3 Lock Appearance

- 3.1 Appearance

### 4 Set Up The Lock

- 4.1 Enter The Management Mode
- 4.2 Add Unlocking Methods
- 4.3 Delete Unlocking Methods
- 4.4 Management Settings
- 4.5 System Settings
- 4.6 Other Settings

### 5 Other Functions

- 5.1 Restore Factory Settings
- 5.2 Battery Replacement
- 5.3 Emergency Power Supply Method
- 5.4 System Restart

### 6 Use The Lock

- 6.1 Outdoor Locking/Unlocking
- 6.2 Indoor Locking/Unlocking

### 7 Basic Parameters

### 8 Restricted Substances

## 1 Important Information

### 1.1 Security

- Before using this smart lock, please read and understand all instructions. Damage caused by failure to follow the instructions is not covered by the warranty
- Suggest using accessories specified by our company
- Only use the lithium battery configured for this product
- Do not disassemble the product forcibly, so as not to sound an alarm or damage the product
- Do not scratch the fingerprint sensor with sharp objects, or it may cause permanent damage
- Do not expose the product to corrosive substances, so as not to damage the protective layer of the shell
- Do not hang objects on the handle, so as not to affect the normal use of the door lock
- To clean the product, please wipe it with a soft cloth
- Do not remove the battery while the device is in operation
- Please choose a professional engineer to install the door lock, and follow the company's installation standards, and do not disassemble or assemble by yourself
- After the door lock is installed and debugged, please modify the default management password set at the factory as soon as possible and keep the mechanical key properly, and do not disclose the password information easily
- After the door lock triggers the low battery alarm, please replace all batteries in time and make sure the installation is correct

### 1.2 Warning

- Do not put the battery near the fire, so as not to explode
  - Do not use an emergency power source that does not comply with safety regulations to power this product
  - Do not short-circuit the pole connections of the battery leads with metal as this may cause an explosion
  - Make sure to replace by LEELEN, LEELEN authorized service centers or professionals
  - Using accessories or components produced by other manufacturers or not specifically recommended by LEELEN may invalidate your warranty
- 

### 1.3 Disposal Of Old Products And Batteries

- Please understand the local electronic product classification collection system by yourself
- Please follow local regulations and do not dispose of old batteries in normal household waste
- Proper disposal of old products helps avoid potential negative impacts on the environment and human health
- Batteries cannot be disposed of with normal household waste

## 2 Install The Lock

### 2.1 Product List

This product list is for reference only, and everything is subject to the actual packaging content.



Front Panel  
(with silicone pad)  
x1

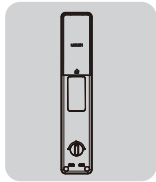

Rear Panel  
(with silicone pad)  
x1

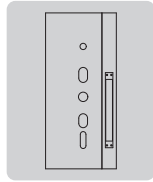

Opening Template  
x1

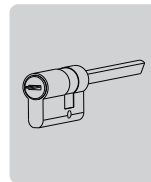

Automatic  
lock core  
x1

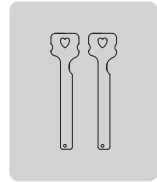

Mechanical  
Key  
x2



IC Card  
x2



Installation Kit  
x1



User's Guide  
x1

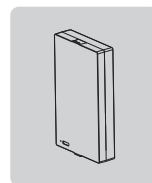

4000mAh Battery  
x1

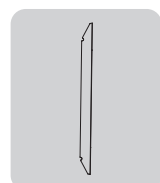

Anti-pinch finger  
baffle x1

### 2.2 Installation Three-dimensional Assembly Drawing

Knowing the three-dimensional assembly diagram of the installation is conducive to understanding the structure of the lock.

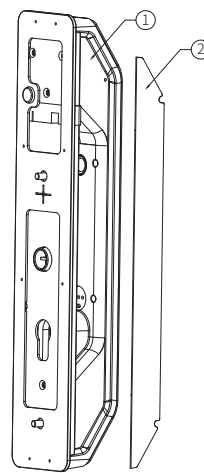
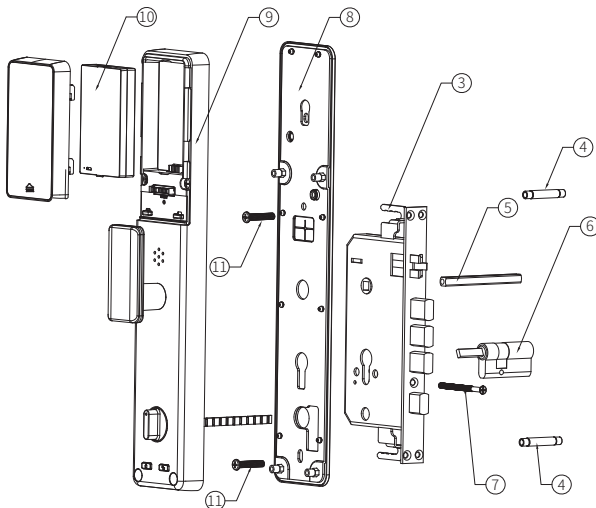

1. Door outer lock (1 set)
2. Anti-pinch finger (1 pcs)
3. Lock body (1 pcs)
4. Double-ended connection stud (2)
5. Square rod (1)
6. Fully automatic lock cylinder (1 pcs)
7. Lock cylinder fixing screw (1 pcs)
8. Rear sealing silicone pad (2 pcs)
9. Rear lock (1 pcs)
10. Lithium battery (1)
11. Connecting screws (4 pcs)

## 2.3 Instructions Before Installation

### 2.3.1 Confirm the door opening direction before installation

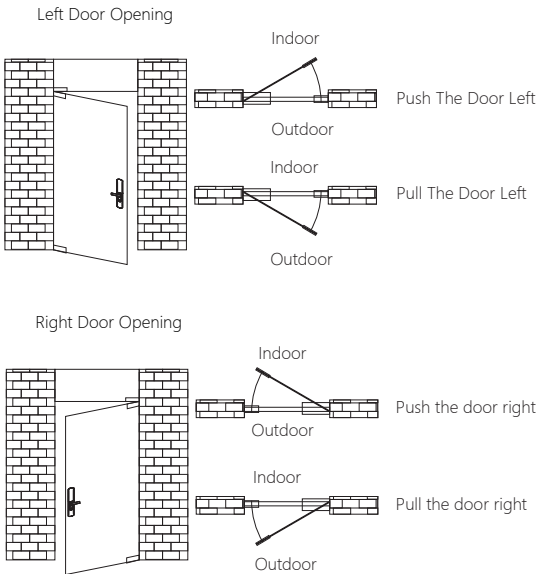

### 2.3.2 Corresponding lock body and bolt direction

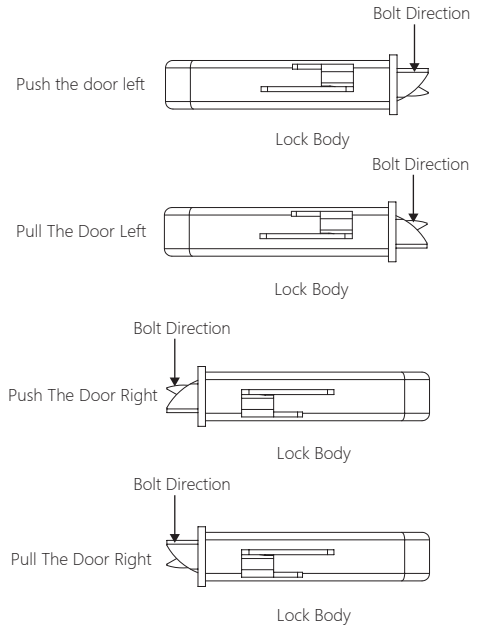

## 2.4 Bolt Direction Reversing

The lock body does not distinguish between push in and pull out. If you need to change the direction (that is, push in to pull out, or pull out to push in), please adjust the direction of the bolt before installation. The specific method is as follows:

- ① The main bolt remains locked
- ② Slightly lift outward, the bolt will automatically pop out of the side panel
- ③ Rotate the latch 180°
- ④ Press the bolt into the side panel after swiveling into position

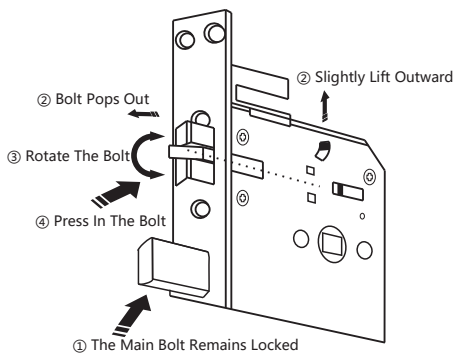

## 2.5 Installation Video

During the door lock installation process, it is necessary to try dangerous professional tools, so please be sure to hire a professional to install it. Before installation, please scan the QR code on the right, watch and follow the installation video to complete the installation.



## 3 Lock Appearance

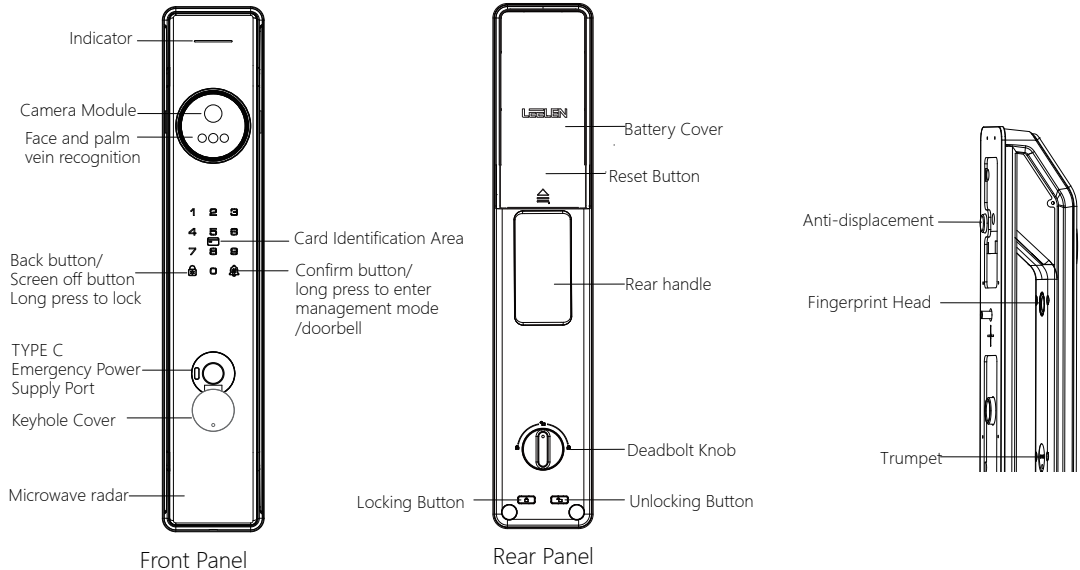

## 4 Set Up The Lock

### 4.1 Enter The Management Mode

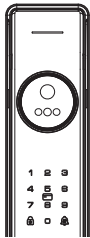

1. Touch the touch area of the keyboard, the keyboard light will light up, and the keyboard will be awakened;
  2. Press and hold the "#" key for 2 seconds to enter the background management
  3. Enter the 6-digit management password according to the voice prompt, and press "\*" to enter the management menu.
- Note: After restoring the factory settings, press and hold the "#" key for 2 seconds and enter the default management password (951058) to enter the settings menu.

Press **1** to add a user; Press the **1** key to enter to add a password. After entering the 6-digit password, enter the password again according to its prompts until the prompt: the operation is successful.

Press **1** to add a user; Press the **1** key to enter the card adding put the card in the card recognition area, until it prompts: the operation is successful.

#### Add user face

Press **1** to add a user; Press the **2** key to enter to add a face. After entering the face, according to its prompts until the prompt: the operation is successful.

#### Add user palmar vein

Press **1** to add a user; Press the **3** key to enter to add a palmar vein. After entering the palmar vein, according to its prompts until the prompt: the operation is successful.

### 4.2 Add Unlocking Methods

In Management Mode:

When adding a user, the door lock will automatically encode the user key, and the user only needs to enter the face, fingerprint, password or card according to the prompts.

#### Add user fingerprint/password/card

Press **1** to add a user; Press the **1** key to add fingerprints, and follow the voice prompts to change different angles to enter fingerprints until it prompts: the operation is successful.

### 4.3 Delete Unlocking Methods

In Management Mode:

Press the **2** key to delete the unlocking method, enter the user number according to the voice prompt, press # to confirm, until it prompts: the operation is successful.

## 4.4 Management Settings

### 4.4.1 Change The Management Password

In Management Mode:

Press the **3** key to enter the management settings, and then press the **1** key to modify the management password. After entering a new 6-digit management password, follow the voice prompts and enter the management password again until it prompts: the operation is successful.

### 4.4.2 Add the management Fingerprint

In Management Mode:

Press the **3** key to enter the management settings, and then press the **2** key to add the management fingerprints, according to the voice prompts, change the angles of your fingerprint until it prompts: the operation is successful.

### 4.4.3 Delete management Fingerprint

In Management Mode:

Press the **3** key to enter the management settings, and then press the **3** key to delete the management fingerprint. According to it prompts, press the # key to confirm until it prompts: the operation is successful.

### 4.4.4 Add the Management Face

In Management Mode:

Press key **3** to enter the management settings, then press key **4** to add a management face, and follow the voice prompts to record. Enter the face credential until the it prompts: The operation is successful.

Note: If there is already a management face, "Already registered" will be prompted.

### 4.4.5 Delete the Management Face

In Management Mode:

Press the **3** key to enter the management settings, then press the **5** key to delete the management face, and follow the voice prompts. Press the # key to confirm until the it prompts: The operation is successful.

Note: If the management face is not set, "Not registered" will be prompted.

## 4.5 System Settings

### 4.5.1 Volume Settings

In Management Mode:

Press the **4** key to enter the system settings, and then press the **1** key to set the volume. According to the voice prompt, press **1** to set the high volume, press **2** to set the midium volume, press **3** to set the low volume, and press **4** to set the mute. It prompts: the operation is successful.

Note: No matter which volume mode is set, the menu indicator sound, alarm sound, and factory reset prompt sound will always maintain a medium volume.

### 4.5.2 Illegal Input Times Settings

In Management Mode:

Press the **4** key to enter the system settings, and then press the **2** key to enter the number of illegal unlocking settings. According to the prompt, enter the unlocking times of 5-9, press # to confirm, until it prompts: the operation is successful. Note: After the setting is completed, if the user fails to unlock for more than the above times, an alarm will be triggered.

### 4.5.3 Remote unlocking Settings

In Management Mode:

Press the **4** key to enter the system settings, then press the **3** key to enter the remote unlock setting, press the **1** key to enable it, press the **2** key to disable it, until it prompts: the operation is successful. remote unlock is enabled by default.

### 4.5.4 Card Encryption Settings

In Management Mode:

Press the **4** key to enter the system settings, then press the **4** key to enter the card encryption setting, press the **1** key to enable it, press the **2** key to disable it, until it prompts: the operation is successful. Encryption is enabled by default. In Admin Mode:

After opening, the use and entry of the card can be more secure and cannot be copied. If disabled, the security level of the card is reduced, but the applicability is enhanced, such as the door lock can be opened by copying the card through the mobile phone.

### 4.5.5 Delay Lock Settings

Press the **4** key to enter the system settings, then press **5** key to enter the delay lock setting, press the **1** key to enable it, press the **2** key to disable it, until it prompts: the operation is successful. Delay lock is enabled by default.

When delayed locking is enabled, the lock tongue will be automatically activated 15 seconds after the smart lock is successfully unlocked.

### 4.5.6 Double Verification Settings

In Management Mode:

Press the **4** key to enter the system settings, then press the **6** key to enter the double verification settings setting, and press the **1** key to enable it, press the **2** key to disable it, until it prompts: the operation is successful. Double verification is disabled by default.

### 4.5.7 Lock type setting

In Management Mode:

Press the **4** key to enter the system settings, then press the **7** key to enter the lock type setting, and press the **1** key to select common lock body, press the **2** key to select detect lock body, until it prompts: the operation is successful. common lock body is selected by default.

## 4.5.8 Proximity recognition setting

In Management Mode:

Press the **4** key to enter the system settings, then press the **8** key to enter the proximity recognition setting, and press the **1** key to enable it, press the **2** key to disable it, until it prompts: the operation is successful. Proximity recognition is enabled by default.

## 4.5.9 Screen off card swiping Settings

In Management Mode:

Press the **4** key to enter the system settings, then press the **9** key to enter the Screen off card swiping setting, and press the **1** key to enable it, press the **2** key to disable it, until it prompts: the operation is successful. Screen off card swiping is disabled by default.

## 4.6 Other Settings

### 4.6.1 Unlocking direction Settings



If the door lock only has the default management password, press 888#, and the voice prompt "Press **1** to open the door on the right, press **2** to open the door on the left, press # to repeat, and press \* to return". After pressing the specified button, the voice prompt "Operation successful"

### 4.6.2 Demo Mode Settings



Press and hold the 0 button for 3 seconds to enter the experience mode settings, and press the **1** key to enable it, press the **2** key to disable it, until it prompts: the operation is successful. Demo mode is disabled by default.

Note: The demo mode option will only appear on the system after no unlocking credentials are added to the door lock or the factory settings are restored.

### 4.6.3 Anti-tampering Alarm Settings



In the case of only the default administrator password, press and hold the 0 button to enter the administrator password to enter the next level menu, and press 8888 continuously to turn on the anti-tampering alarm, and press 9999 continuously to turn off the anti-tampering alarm.

## 5 Other Functions

### 5.1 Restore Factory Settings

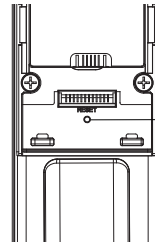

Indoor | Rear Panel

Open the battery cover, click the RESET button, press the RESET button for 5 seconds with a pin, and press the button within 10 seconds according to the voice prompt. Finally, the voice prompt will be heard, and the door lock system will be initialized successfully.

### 5.2 Battery Replacement

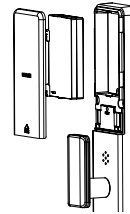

Indoor | Rear Panel

When the system voice prompts that the battery is low, you need to remove the lithium battery to charge it (the red light indicates charging, and the blue light indicates that it is fully charged). Replace it in time after it is fully charged.

### 5.3 Emergency Power Supply Method

When the battery voltage is low and the door cannot be opened from the outside, you can open the key cover, connect a 5V or higher power bank to the emergency power supply port (Type-C), charge for more than five minutes, and then unlock the door with a fingerprint, password or card.

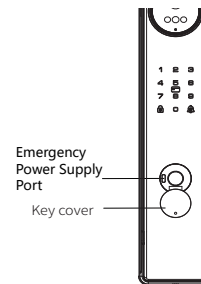

Outdoor | Front Panel

### 5.4 System Restart

If you need to restart the system, you can use a 5V or higher power bank as an emergency power source, power on the door lock through the Type-C port, and then restart it.



## 6 Use The Lock

### 6.1 Outdoor Locking/Unlocking

#### Face recognition Unlocking

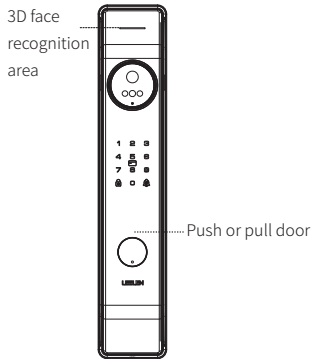

Outdoor | Front Panel

When the user approaches the door lock, the door lock automatically starts face recognition. After hearing the door opening prompt tone, push/pull the handle from the front within 3 seconds to open the door.

#### Password Unlocking

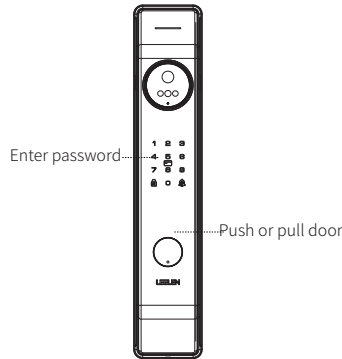

Outdoor | Front Panel

After waking up the screen, enter the 6-digit password and press the "#" key to confirm. After the password is correct, you can only push the door open within 3 seconds.

#### Fingerprint Unlocking

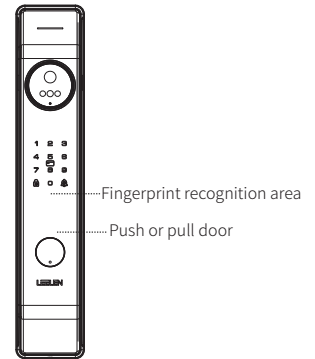

Outdoor | Front Panel

Put an added finger on the fingerprint recognition area. After the verification is successful, please push or pull the handle to open the door within 3 seconds.

▲ If the wrong unlocking credentials (password/face/fingerprint) are entered continuously within 5 minutes, the smart lock will be locked for 90 seconds. After successful unlocking, if the door is not opened within 5 seconds, the smart lock will re-lock automatically.

#### Card Unlocking

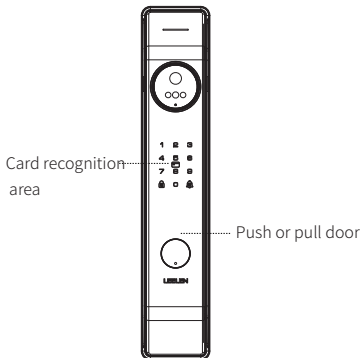

Outdoor | Front Panel

Place the smart card at the card recognition area, and after hearing the door opening prompt, push/pull the handle to open the door within 3 seconds (default).

#### Key Locking

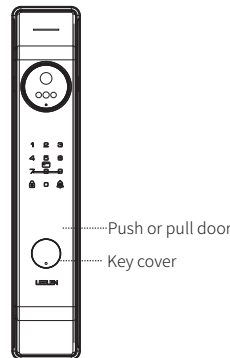

Outdoor | Front Panel

Press the key cover to open it, insert the key and turn it to unlock, push/pull the handle to open the door. Note: Do not leave the emergency key in the house, choose a safe and accessible place to keep it for use in an emergency.

#### Lock key lock

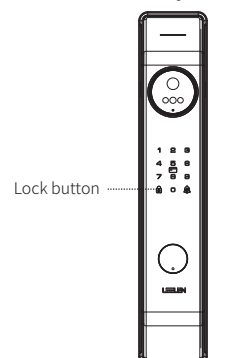

Outdoor | Front Panel

After closing the door, wake up the door lock to light up the button light. If there is no input, long press the lock button for 0.5s to lock. (If you choose to detect the lock body, it will automatically lock after closing the door)

## 6.2 Indoor Locking/Unlocking

### Indoor Locking

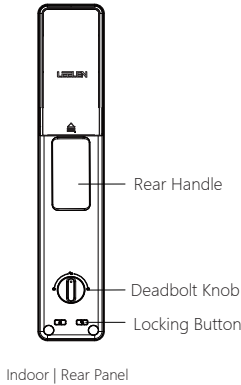

- ① When closing the door, click the unlock button, and after hearing the unlock prompt tone, push/pull the quick-open handle to open the door within 3 seconds.
- ② After closing the door, rotate the quick-open handle to open the door according to the actual opening/closing direction.

### Indoor Unlocking

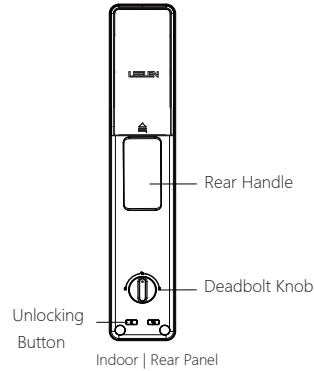

- ① After closing the door, click the lock button to lock the door. (If you choose to detect the lock body, the door will be automatically locked after closing)
- ② After closing the door, according to the actual opening/closing direction, rotate the quick-open handle to lock the door.
- ③ After locking, you can also rotate the anti-lock knob to lock the door, which improves home safety.

## 7 Basic Parameters

Front panel (L\*W\*H): 428\*83\*66mmmm  
 Rear panel (L\*W\*H): 413\*79\*73mm  
 Shell Material: Aluminum alloy + IML panel  
 Lock body type: 6068 standard lock body/Overlord lock body  
 Input power: 4000mAh Lithium Battery  
 Emergency power supply interface: Type-C 5V power supply port  
 Wifi Module: Wi-Fi IEEE 802.11b/g/n 2.4GHz  
 Working temperature: -25°C~+70°C  
 Working humidity: ≤95%RH, non-condensing  
 Protection class: IP52  
 User capacity:  
 100 faces (99+management 1)  
 100 palm veins  
 100 fingerprints (99+management 1)  
 100 passwords (99+management 1)  
 1 one-time password  
 100 cards  
 Environmental adaptability level: Level II  
 Product safety level: Class B  
 Lock cylinder security level: C level

## 8 Restricted Substances

Part Name	Toxic and hazardous substances or elements					
	Pb	Hg	Cd	Cr6+	PBB	PBDE
Metal Parts	○	○	○	○	○	○
Plastic Parts	○	○	○	○	○	○
Board Assembly*	X	○	○	○	○	○
Power Cord/Connection Cord	X	○	○	○	○	○
Lithium Battery	X	○	○	○	○	○

This form is prepared according to the provisions of SJ/T 11364:  
 ○: Indicates that the content of the hazardous substance in all homogeneous materials of the part is below the limit requirement in GB/T 26572  
 X: Indicates that the content of the hazardous substance in at least one homogeneous material of the part exceeds the limit requirement specified in GB/T 26572  
 \*: Circuit board assembly includes printed circuit board and its components, such as resistors, capacitors, integrated circuits, etc.